

FLUOROPLASTIC PRODUCTS

for Semiconductor and Liquid Crystal Industries

Butt Welding Products...4

Butt welding products

Through welding, a continuous construction piping system without the use of couplings can be achieved. Compared to piping using couplings, our butt welding method is lightweight and compact.

Snake Hose...3

Snake Hose (S series)

A PTFE hose shaped into a continuous spiral design. With excellent flexibility, oscillation and amplitude can be absorbed.

PFA Tube...3

PFA tube

Using highly pure PFA polymer, this is a tube with excellent internal smoothness and reduced ion dissolution. From molding and testing, to packing, all processes are carried out in a contamination-free environment.

Injection Molded Products...2

Injection molded products

Molded products using materials such as fluoroplastic or various engineering plastics. We create these products from start to finish; from the design of the mold throughout production. All processes from molding, to washing, testing and packing, are carried out in a contamination-free environment.

Bubble-Generating Unit...2

Bubbling nozzle

A heat and chemical resistant bubble producing unit. With use of chemical liquids even more effective cleaning can be achieved.

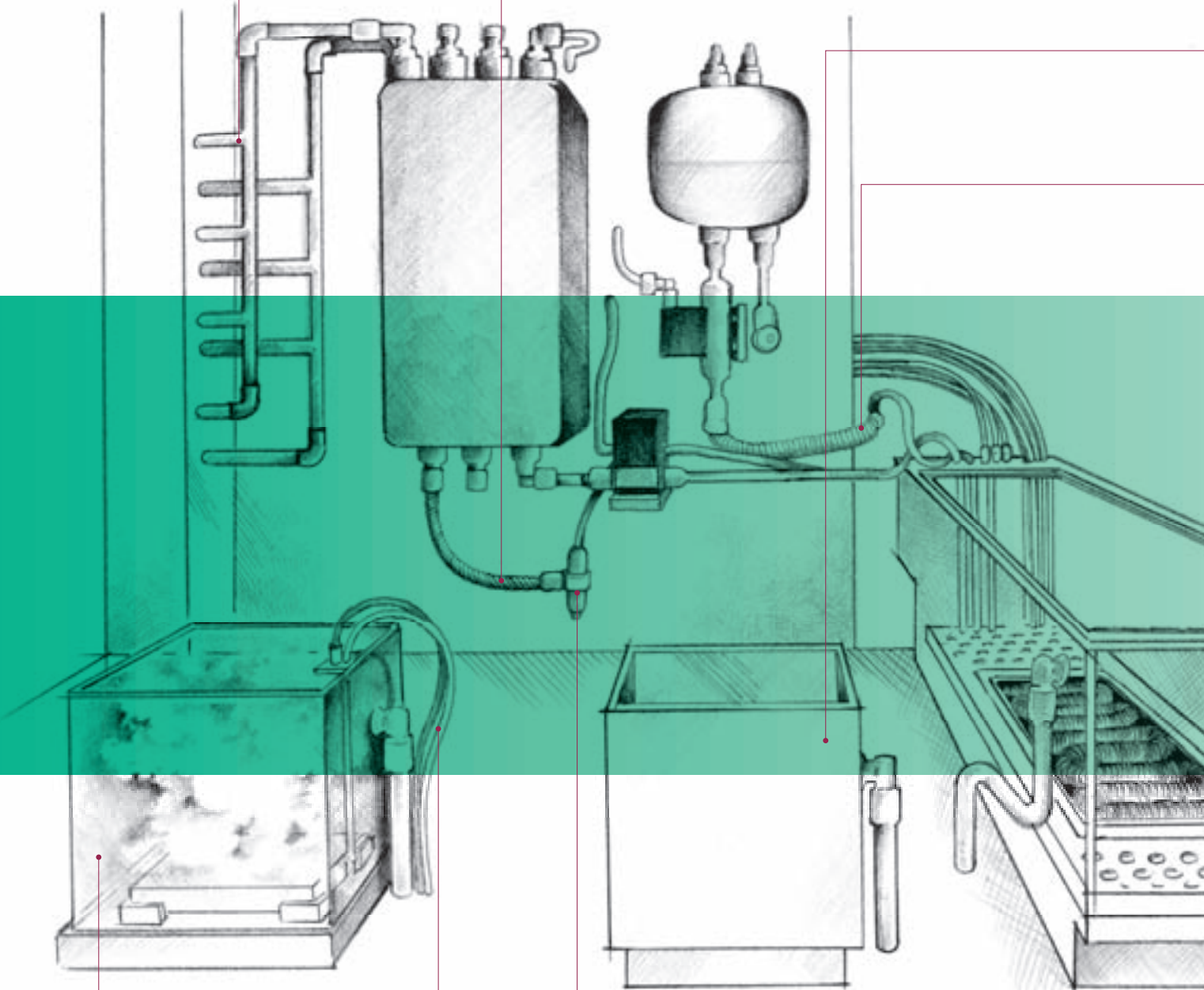

Since our founding as a general fluoroplastic related products processing maker, we have continuously challenged and pushed the cutting edge of our industry field. Particularly accompanying the remarkable technical innovations of recent years in the areas of the semi-conductor and liquid crystal fields, we have gained a reputation by meeting the demands for sanitary fluoroplastic products of a high quality. In order to accommodate these needs we make use of the latest factory facilities with a base of strict quality control. From molding production to testing and packing, everything is carried out in a contamination-free environment. Our motto is, "Ever creating products for customer satisfaction."

Chukoh-Flo fluoroplastic products are stepping up to fill the needs of the semi-conductor and liquid crystal industries

PTFE Welding Tank...1

PTFE Welded tank

Made by our welding technicians. Available in a wide range of shapes and sizes to meet your needs, we can also fill orders for small lots.

Snake Hose...3

Snake Hose (I series)

A PFA hose of continuously ridged shaping. Appropriate for piping needs of extreme bending radius, or small and pliable or narrow areas.

PTFE Tank...1

PTFE Solid tank

A PTFE construction seamless solid mold. Shows high dependability and won't lose its form or leak due to heat.

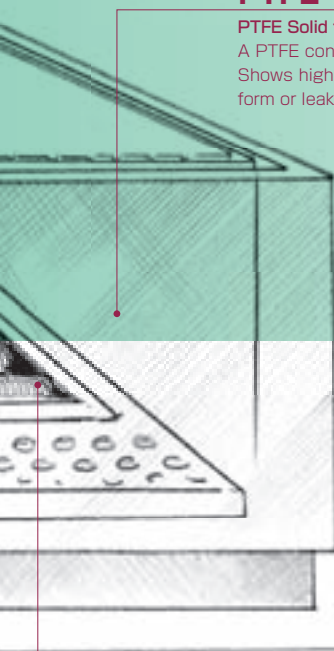

Heater Unit...2

Heater unit

By use of a coil heater, this unit is compact while showing a high heating capability. Other than the heating component itself, this is an entirely fluoroplastic-construction unit.

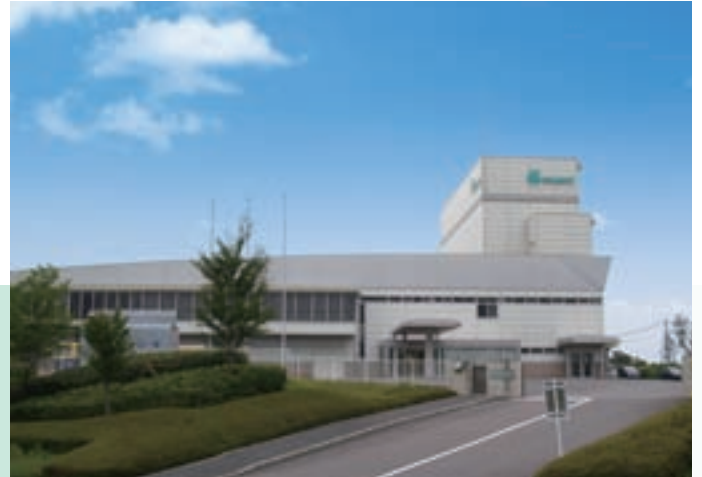

Utsunomiya Plant



Clean room (tube processing)



Clean room (injection processing)

※Please see indicated page for product information.

PTFE Tank

This is a PTFE tank made using an isostatic molding process. With this solid body seamless tank there is no worry of liquid leakage. Available in an abundance of sizes such as basic tank, circular tub, overflow vat, and more. With many varieties you can choose the shape which best fits your purposes.

- Coupling parts and accessories welding is possible.
- Drain positioning can be designed to fit customer needs.
- Tapered manufacturing of the lower portion is possible.
- For other specifications please consult with us.

■ please refer to dimensions table at the back of this catalogue.



PTFE Welding Tank

Welding technicians with a high level of technique and a wealth of knowledge produce this product to satisfy customer demands.

- As a mold is not necessary, this tank is an economical choice for small lots.
- It is possible to design tanks to fit your purpose.



Machined Products

Using PTFE, a selection of fluoroplastic materials (sheet, rod, pipe) can be manufactured to the customer's design specifications.



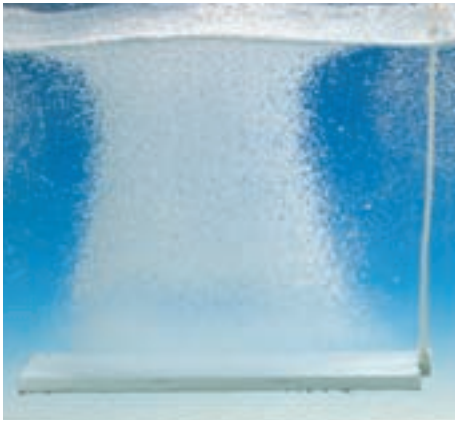

Bubbling sheet

A PTFE-construction bubble producing unit. With its micro-bubbles, this unit is effective for cleaning and mixture of chemical liquids.

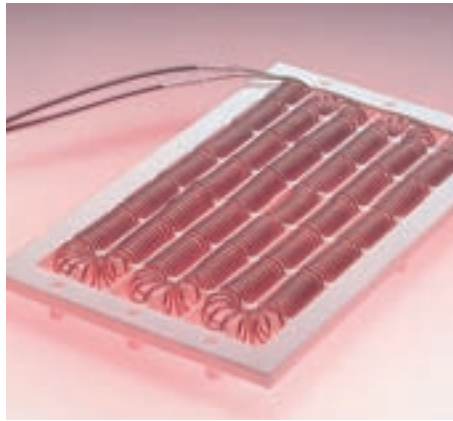

Cartridge heater unit

Other than the heat generation device itself, this is an all fluoroplastic heater. With excellent heat and chemical product resistance, this heater is useful in heating and maintaining the temperature of chemical liquids.

■please refer to dimensions table at the back of this catalogue.



Injection molding products

We carry out injection molding utilizing high performance plastic such as our fluoropolymer. Products related to semi-conductors demand a high degree of sterilization. For this reason, from molding to testing and packing, all processes take place in a strictly monitored sterile environment to prevent even the smallest degree of contamination. In order to have a faster and more precise response to customer requests, we design and manufacture our metal molds.



The design process takes place using CAD.



Lining

We create extremely corrosion-resistant fluoropolymer linings.

Although rotation molding is generally used, depending on the purpose and use, we are able to accommodate a variety of lining methods.

Mostly for linings of piping or tanks, we can also accommodate the needs of complex shapes and large materials applications. Basic materials can also be manufactured by request.



PFA Tube

A clear push-molded PFA tube. With high smoothness of the internal wall surface and extremely reduced ion dissolution, this tubing does not impact the flow or fluid.

● For use at temperatures up to 260°C

■ please refer to dimensions table at the back of this catalogue.



PTFE Tube

A push-molded PTFE tube. At customer request a filler can be added and colored product can also be manufactured.

● For use at temperatures up to 260°C.

■ please refer to dimensions table at the back of this catalogue.



Snake Hose S series

A fluoroplastic hose molded into a spiral design. Suited to piping which requires flexibility.

■ please refer to dimensions table at the back of this catalogue.

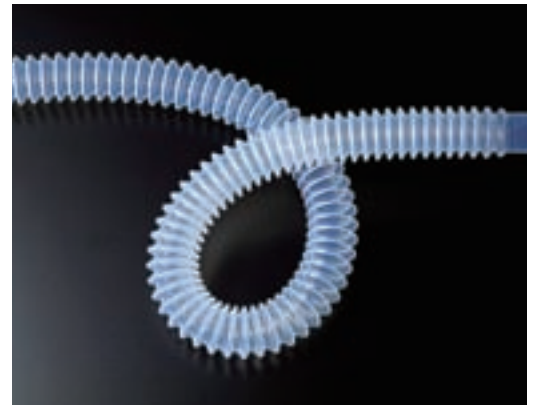

Snake Hose I series

A PFA hose shaped into a continuous ridging (accordion) design. An extremely small bending radius and excellent elasticity makes this hose well suited for uses requiring freedom of movement.

■ please refer to dimensions table at the back of this catalogue.



Sheet



Rod



Pipe

PTFE Manufacturing use material

PTFE push molded or compressed into planks, rods and piping. Can also be manufactured with a variety of fillers on request.

■ please refer to dimensions table at the back of this catalogue.

PFA welded fitting

By welded unification of pipe and coupling, the result is light-weight, compact, and maintenance free compared with traditional joint piping methods.



Marking tube

These labeled tubes are used for indication of type, or marking the flow of liquids. Possible for use with highly acidic or alkaline environments, the fit-in joint style makes for simple attachment and removal.

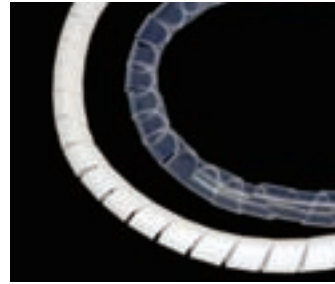
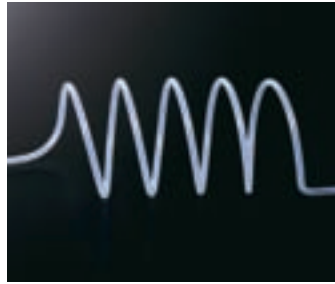
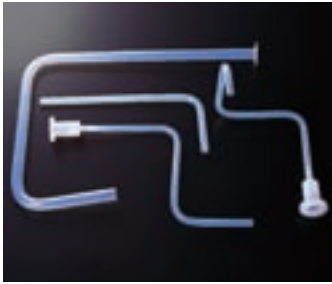

Bent Processing

Three dimensional bending and custom shapes such as flaring can be manufactured to your needs.



Coil tube

For use where versatile and flexible piping is necessary.

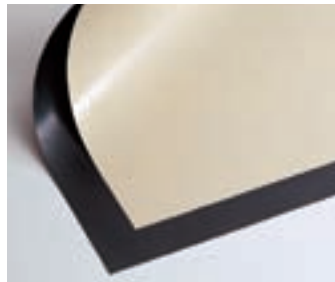

Spiral cut tube

Useful in not only grouping cable and wiring, but helps protect from abrasion and unnecessary wear.



Cushion materials

For heat-resistance, ease of removal, and cushioning in glass substrate molding processes, by using ACF in the TAB process.

■please refer to dimensions table at the back of this catalogue.

Skived tape

A PTFE film available in a wealth of width and thickness variations. Used mainly in ACF bonding processes.



AGF-100 FR

A fabric-base (fluoroplastic-coated glass cloth) tape with excellent dimensional stability. Also available in wide type with a peel-able paper backing.

Fabric

A fluoroplastic-coated glass cloth with excellent dimensional stability. Mainly used for ease of removal in glass substrate molding processes.

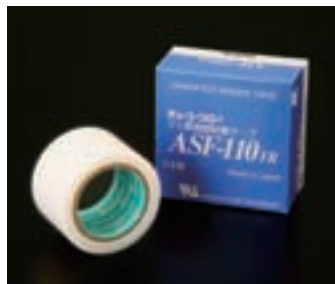

ASF-110 FR

A PTFE film tape. Clean milky-white in color, this tape has excellent flexibility and surface smoothness. Also available in wide type with a peel-able paper backing.

NI sheet

Skived tape or fabric is combined with silicon rubber to make this cushion sheet. With high performance even through repeated use, expect cost-effective results.

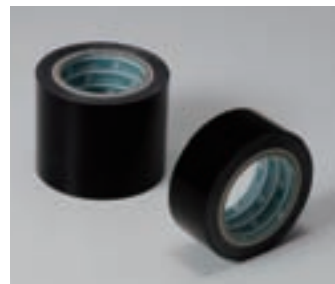

AGB-100

An antistatic fabric-base (fluoroplastic-coated glass cloth) tape. This tape is suitable uses where static electricity is unacceptable. Also available in wide type with peel-able paper backing.

Adhesive tapes

To a variety of fluoroplastic base materials, an adhesive agent is applied to one side creating a tape with excellent heat resistance and ease of removal. Available in various width and thickness.

■please refer to dimensions table at the back of this catalogue.

PTFE Tank

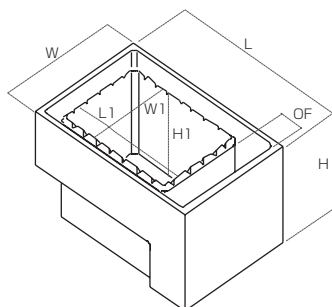

Overflow tank							
External dimensions(mm)			Internal dimensions(mm)			overflow	vat capacity
W	L	H	W1	L1	H1	OF	(L)
270	310	250	200	200	235	55	9.0
300	377	265	220	220	245	95	11.4
310	420	280	240	230	260	130	13.8
270	500	235	200	340	220	100	14.3
320	390	295	240	250	275	70	15.9
350	440	310	250	270	288	80	18.8
295	550	260	205	410	240	75	19.3
330	555	280	240	410	260	75	24.6
340	592	278	250	452	263	75	28.6
420	520	310	310	340	290	95	29.5
325	610	320	255	430	300	125	31.8
380	485	365	290	350	345	75	34.0
310	665	390	220	480	365	90	37.5
330	590	375	270	440	355	90	41.0
390	705	350	280	570	325	50	50.3
530	480	460	420	320	440	90	57.8
415	710	370	315	585	345	55	61.7
430	670	400	350	520	380	80	67.3
548	798	580	416	628	565	66	145.0

※For dimensions not listed here please make a special consultation.

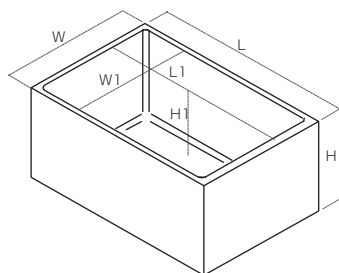

Simple Tank								
External dimensions(mm)			Internal dimensions(mm)			Side thickness	Bottom thickness	capacity
W	L	H	W1	L1	H1	(mm)	(mm)	(L)
130	130	205	100	100	190	15	15	1.9
150	250	250	130	230	235	10	15	7.0
170	250	325	140	220	310	15	15	9.5
240	255	260	210	225	245	15	15	11.6
150	380	365	120	350	350	15	15	14.7
300	400	190	270	370	175	15	15	17.5
330	330	235	300	300	220	15	15	19.8
270	440	280	240	410	265	15	15	26.1
310	330	370	280	300	355	15	15	29.8
200	480	440	170	450	425	15	15	32.5
420	520	210	390	490	190	15	20	36.3
320	380	420	290	350	400	15	20	40.6
540	540	200	510	510	185	15	15	48.1
340	590	340	310	560	320	15	20	55.6
340	510	480	310	480	465	15	15	69.2
530	560	355	500	530	340	15	15	85.0
430	675	425	390	635	405	20	20	100.3
460	600	540	420	560	520	20	20	122.3
730	730	665	690	690	645	20	20	307.1

※For dimensions not listed here please make a special consultation.

Cartridge Heater			
Product No.	Dimensions(mm)	Voltage(V)	Output(W)
CH-1A-1-8	130×240×20H	100	800
CH-2A-1-16	130×240×50H	100	1600
CH-2A-2-16	//	200	1600
CH-2A-3-19	//	220	1900
CH-1B-1-7	180×200×20H	100	700
CH-2B-1-14	180×200×50H	100	1400
CH-2B-2-14	//	200	1400
CH-2B-3-17	//	220	1700
CH-1C-1-18	180×258×20H	100	1800
CH-1C-2-18	//	200	1800
CH-1C-3-21	//	220	2100
CH-2C-2-36	180×258×50H	200	3600
CH-1E-1-16	218×250×20H	100	1600
CH-1E-2-16	//	200	1600
CH-1E-3-20	//	220	2000
CH-2E-2-32	218×250×50H	200	3200
CH-1D-1-15	186×292×20H	100	1500
CH-1D-2-15	//	200	1500
CH-1D-3-18	//	220	1800
CH-2D-2-30	186×292×50H	200	3000
CH-2D-3-36	//	220	3600
CH-1F-1-45	230×230×20H	100	450
CH-1F-2-18	//	200	1800
CH-1F-3-21	//	220	2100
CH-2F-2-36	230×230×50H	200	3600
CH-1G-1-35	230×248×20H	100	350
CH-1G-1-14	//	100	1400
CH-1G-2-14	//	200	1400
CH-2G-2-28	230×248×50H	200	2800
CH-2G-3-34	//	220	3400

Cartridge Heater

PFA Tube

PFA Tube							
	Inside diameter x Outside diameter (mm)	Tubing thickness (mm)	Length(m)				
			10	20	30	50	100
Size in millimeters	3x2	0.5					
	4x2	1.0	●		●	●	●
	4x3	0.5	●				
	6x4	1.0	●	●	●	●	●
	8x6	1.0	●	●	●	●	●
	10x8	1.0	●	●	●	●	●
	12x10	1.0	●	●	●	●	●
	19x16	1.5					
Size in inches	25x22	1.5					
	3.18x2.18	0.5					
	4.75x3.15	0.8					
	6.35x3.95	1.2	●		●	●	●
	9.53x6.35	1.59	●		●	●	●
	12.7x9.53	1.59	●	●	●	●	●
	19.05x15.87	1.59	●	●	●	●	●
25.4x22.2	1.6	●		●			

● indicates in stock.

PTFE tube

PTFE tube							
	Inside diameter x Outside diameter (mm)	Tubing thickness (mm)	Length(m)				
			10	20	30	50	100
Size in millimeters	4x2.5	0.75					
	6x4	1.0	●	●	●	●	●
	8x6	1.0	●	●	●	●	●
	10x7.5	1.25					
	12x9	1.5					
Size in inches	3.18x2.18	0.5					
	4.75x3.15	0.8					
	6.35x3.95	1.2					
	9.53x6.33	1.59					
	12.7x9.53	1.59					

● indicates in stock.

Snake Hose

Snake Hose I series (PFA type)							Measurement unit(mm)	
General thickness (inch)	Outside diameter A	Inside diameter B	Hose thickness C	Effective radius D	Bending radius (R)	Breakdown pressure at normal temperature (Mpa)	Length L1,L2	Overall length L3
1/4	6.82	6.0	0.41	5.5	1.6	1.5	19	Designated length 0.15~2m
3/8	10.30	9.2	0.55	8.5	2.4	1.3	25	
1/2	13.46	12.1	0.68	11.0	3.2	1.3	25	
3/4	20.26	18.7	0.78	17.4	4.8	0.9	38	
1	26.66	24.8	0.93	23.0	6.4	0.8	50	

※effective radius is a referential value.

※For dimensions not listed here please make a special consultation.

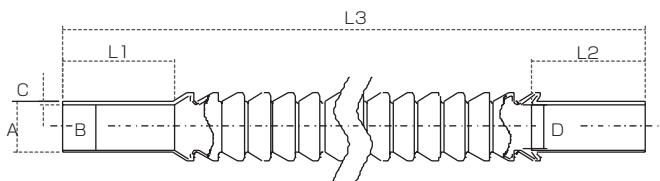

Snake Hose S series (PTFE type)							Measurement unit(mm)	
General thickness (inch)	Outside diameter A	Inside diameter B	Hose thickness C	Effective radius D	Bending radius (R)	Breakdown pressure at normal temperature (Mpa)	Length L1,L2	Overall length L3
4×7	5.5~7.0	4.5~6.0	0.5	4.0	10	1.5	~30	A maximum 10m
5×8.5	6.5~9.0	5.5~8.0		5.0	14	1.1		
7×11	8.5~11.0	7.5~10.0		7.0	16	0.8	~35	
9×13	10.5~13.0	9.5~12.0		9.0	18	0.6	~40	
11×16.5	12.5~15.5	11.5~14.5		11.0	20	0.5		

※effective radius is a referential value.

※For dimensions not listed here please make a special consultation.

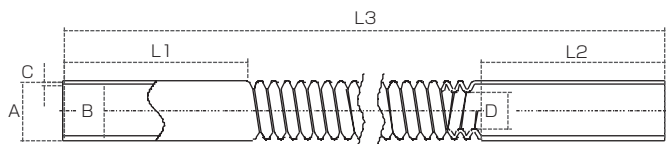

Manufacturing use material

PTFE Sheet				Measurement unit(mm)	
Thickness	Size			Irregularity margin	
	300×300	500×500	1000×1000	Thickness	Size
3	●	●	●	+0.6, 0	+10.0
4	●	●	●		
5	●	●	●		
6	●	●	●		
7	●	●	●		
8	●	●	●	+1.2, 0	
9					
10	●	●	●		
11					
12	●	●	●	+1.5, 0	
13					
14					
15	●	●	●	+1.8, 0	
16					
17					
18					
19				+2.1, 0	
20	●	●	●	+2.7, 0	
21					
22					
23					
24					
25	●	●	●		
26					
27					
28					
29					
30	●	●	●		
31					
32					
33					
35					
36					
37					
38					
40					
41					
42					
45					
46					
47					
49					
50					
51					
53					
55					

● indicates in stock.
For dimensions not listed here please make a special consultation.

PTFE Push-pipe			Measurement unit(mm)		
Outside diameter	Inside diameter	Length	Irregularity margin		
			Outside diameter	Inside diameter	Length
16	3.5	1000	+0.7, 0	0, -1.0	+2%.0
	6				
	8				
	9				
● 10					
3.5	+1.5, 0		0, -1.0		
4.5					
8					
● 10					
3.5	+2.0, 0		0, -1.0		
6					
● 10					
16					
3.5	+1.5, 0	0, -1.0			
6					
8					
● 10					
● 15	+2.0, 0	0, -1.5			
3.5					
6					
8					
● 10	+2.0, 0	0, -2.0			
● 15					
20					
● 30					
● 10	+3.0, 0	0, -1.5			
15					
25					
● 20					
● 25	+3.0, 0	0, -2.5			
33.5					
25					
30					
35	+3.0, 0	0, -3.0			
40					

● indicates in stock.
For dimensions not listed here please make a special consultation.

PTFE Push-rod		Measurement unit(mm)	
Diameter	Length	Irregularity margin	
		Diameter	Length
● 5	1000	+0.6, 0	+2%.0
● 6			
6.5			
● 7			
7.3			
7.5			
● 8			
● 9			
● 10			
● 11			
● 12			
● 13			
● 14			
● 15			
● 16			
17			
● 18			
19			
● 20			
● 22			
● 25			
● 30			
● 35			
● 40			
● 45			
● 50			

● indicates in stock.
For dimensions not listed here please make a special consultation.

PTFE Compression rod		Measurement unit(mm)	
Diameter	Length	Irregularity margin	
		Diameter	Length
50	100	+4.0, 0	+5.0
55			
● 60			
● 65			
● 70			
75			
● 80			
85			
● 90			
95			
● 100			
110			
● 120			
130			
140			
150			
160			
170			
180			

● indicates in stock.
For dimensions not listed here please make a special consultation.

PTFE Sleeve			Measurement unit(mm)
Outside diameter	Inside diameter	Length	
50~200	Consultation is available	100	

For dimensions not listed here please make a special consultation.

Skived Tape				
Thickness (mm)	Width (mm)			Length
	300mm	500mm	1000mm	
0.05	○			10m
0.08	○			
0.1	○	○		
0.13	○			
0.15				
0.2	○	○		
0.25				
0.3	○	○		
0.4	○			
0.5	○	○		
0.6				
0.7				
0.8	○	○		
0.9				
1.0	○			

NI sheet			
	Composite materials	Width(mm)	Length(m)
NIC type	heatproof film + silicon rubber	4~450	1~50
NIG type	Fluoroplastic-coated glass cloth + silicon rubber	4~10	10~20

*Other size is available. Please ask our sales dept.

Cushion materials

○ indicates normally in stock.
*For dimensions not listed here please make a special consultation.

Fabric												
Grade	Product number	General thickness (mm)	Maximum width (mm)	Weight (g/㎡)	Tensile strength (N/cm)		Tear strength (N)		Breakdown voltage (kV)	Volume resistivity (Ω-cm)	Surface resistivity (Ω)	
					Vertical	horizontal	Vertical	horizontal				
G Type Fabric	Natural / plain weave	FGF-400-2	0.045	1000	70	60	50	4	4	1.0	>10 ¹⁵	>10 ¹⁴
		FGF-500-2	0.050	1000	100	65	50	4	4	1.5		
		FGF-300-3	0.070	1000	110	150	100	8	6	-		
		FGF-400-3	0.075	1000	130	150	90	7	5	3.8		
		FGF-500-3	0.080	1000	165	150	90	6	4	4.9		
		FGF-300-4	0.095	1000	135	240	140	20	7	-		
		FGF-400-4	0.095	1000	175	290	160	13	5	4.3		
		FGF-500-4	0.100	1000	215	290	160	10	5	5.0		
		FGF-300-6	0.110	1550	170	260	210	20	12	-		
		FGF-400-6	0.115	1550	230	280	250	9	9	4.4		
		FGF-500-6	0.125	1550	265	280	250	9	9	4.5		
		FGF-300-8	0.155	1000	190	310	310	40	40	-		
		FGF-400-8	0.160	1000	265	330	310	20	20	3.5		
		FGF-500-8	0.170	1000	320	330	310	16	16	4.8		
		FGF-300-10	0.220	2300	360	410	390	30	30	-		
		FGF-400-10	0.230	2300	425	500	410	35	31	5.9		
		FGF-500-10	0.240	2300	500	500	410	30	30	6.2		
		FGF-400-14	0.330	2500	485	710	540	78	61	5.1		
		FGF-500-14	0.350	2500	580	710	540	62	51	5.3		
		FGF-400-22	0.540	2500	700	1180	750	210	150	6.7		
FGF-500-22	0.560	2500	840	1180	750	165	120	7.1				
FGF-500-21	0.580	2300	1125	820	650	151	95	6.0				
FGF-400-35	0.915	2500	1220	1040	820	220	190	7.1				
FGF-500-35	0.925	2500	1490	1040	820	180	160	7.2				
Natural / Satin weave	FGF-521-24	0.650	2300	1210	1380	1380	96	94	3.7			
	Natural / mesh	FGF-410-18	0.550	2000	485	520	740	-	-	-	-	-
		FGF-410-20	0.750	3000	630	840	570	-	-	-	-	-
FGF-410-30		0.950	2100	470	350	440	-	-	-	-	-	
antistatic (B type)/ plain weave	FGB-500-3	0.080	1000	150	150	130	8	7	-	<10 ⁹	<10 ⁹	
	FGB-500-6	0.130	1550	255	300	250	12	12	-			
	FGB-500-10	0.245	2300	485	470	450	43	40	-			
	FGB-500-14	0.385	2500	745	860	660	65	60	-			
antistatic (C type)/ Plain weave	FGC-500-6	0.130	1000	265	270	260	9	9	-	<10 ⁹	<10 ⁹	
	FGC-500-10	0.240	1000	500	490	410	26	25	-			
A Type Fabric	Natural / plain weave	FAF-500-6	0.110	1000	170	610	480	79	53	3.9	>10 ¹⁵	>10 ¹⁴
		FAF-500-8	0.155	1000	220	840	700	179	168	4.5		
		FAF-500-12	0.310	1000	440	1800	1400	420	400	5.1		
		FAF-500-14	0.350	1550	575	1800	1300	370	520	5.5		
Natural / mesh	FAF-410-30	1.100	2300	415	1100	1200	-	-	-	-	-	
	FNP-400-10	0.185	800	230	260	200	40	25	-	>10 ¹⁵	>10 ¹⁴	
Test method	-	-	-	-	-	JIS L 1096 (Cut-strip method)	JIS L 1096 (Trapezoid method)	JIS K 7137-1	JIS K 6911			

*For dimensions not listed here please make a special consultation.
*The characteristic values of this table are general characteristics and are not standard values.

Adhesive Tape

AGF-100			
General thickness (mm)	Width (mm)	Length (m)	Maximum usage temperature
0.13	13, 19, 25, 30, 38, 50, 100 150, 200, 250, 300, 450 (widest)	10	200°C
0.15			
0.18			
0.30			

※For dimensions not listed here please make a special consultation.

AGB-100			
General thickness (mm)	Width (mm)	Length (m)	Maximum usage temperature
0.13	13, 19, 25, 30, 38, 50, 100 150, 200, 250, 300, 400, 450 (widest)	10	200°C
0.18			

※For dimensions not listed here please make a special consultation.

ASF-110			
General thickness (mm)	Width (mm)	Length (m)	Maximum usage temperature
0.08	13, 19, 25, 30, 38, 50, 100 150, 200, 250, 300, 350 (widest)	10	200°C
0.13			
0.18			
0.23			

※For dimensions not listed here please make a special consultation.

Typical Properties of Fluoroplastics

	Property	Unit of measurement	Testing method			PTFE	PFA	FEP	PCTFE	ETFE	ECTFE	PVDF
Physical	Melting point	℃	JIS K6935	ISO 12086	ASTM D4591	327	310	260	220	270	245	151-178
	Specific Gravity	g/cm ³	K7112	1183	D792	2.13-2.20	2.12-2.17	2.15-2.17	2.10-2.20	1.73-1.74	1.68-1.69	1.75-1.78
Mechanical	Tensile strength	MPa	K7162	527	D638	20-35	25-35	20-30	31-41	38-42	41-48	30-70
	Elongation	%	see above	see above	see above	200-400	300-350	250-330	80-250	300-400	200-300	20-370
	Compression strength	MPa (10% transformation)	K7181	604	D695	10-15	15-20	14-19	31-51	40-50	35-40	32-74
	Izod impact strength	J/m	K7110	180	D256	150-160	no breakdown	no breakdown	135-145	no breakdown	no breakdown	160-375
	Hardness (Rockwell)	(R scale)	K7202	2039	D785	R20	R50	R50	R80	R50	R50	R93-116
	Hardness (Shore)	(D scale)	K7215	2039	D2240	D50-55	D62-66	D60-65	D75-80	D67-78	D53-57	D64-79
	Flexural Modulus	GPa	K7171	178	D790	0.53-0.58	0.54-0.64	0.55-0.67	1.25-1.79	0.90-1.20	0.66-0.69	0.60-1.99
	Tensile Modulus	GPa	K7162	527	D638	0.40-0.60	0.31-0.35	0.32-0.36	1.03-2.10	0.70-0.85	1.55-1.70	0.37-2.58
	Coefficient of Kinetic Friction	(0.69MPa,3m/min)	K6935		D1894	0.1	0.2	0.3	0.4	0.4	0.4	0.4
Thermal	Thermal Conductivity	W/m · K	A1412	8302	C177	0.23	0.19	0.2	0.22	0.24	0.16	0.17
	Specific Heat	10 ³ J/kg · K	K7123			1.0	1.0	1.2	0.9	2.0	2.0	1.2
	Linear Coefficient of Thermal Expansion	10 ⁻⁵ /℃			D696	10	12	9	6	6	8	16
	Ball pressure temperature	℃	Based on reports using the Ball Pressure testing system for heat plasticity plastics used in electric products.			180	230	170	170	185	180	150
	Thermal distortion Temperature	℃	K7191	75	D648							
		(1.81MPa)				55	47	50	90	74	77	100
		(0.45MPa)				120	74	72	126	104	116	156
Maximum Service Temperature (continuous)	℃	K7226	2578		260	260	200	120	150	150	150	
Electric	Volume resistivity	Ω · cm (50%RH,23℃)	K6911	IEC60093	D257	>10 ¹⁸	>10 ¹⁸	>10 ¹⁸	>10 ¹⁸	>10 ¹⁷	>10 ¹⁵	>10 ¹⁵
	Dielectric strength (at short time)	MV/m (3.2mm thickness)	K6935	IEC60243	D149	19	20	22	22	16	20	11
	Dielectric Constant relative static permittivity	(60Hz)	K6935	IEC60250	D150	2.1	2.1	2.1	2.6	2.6	2.6	8.4
		(10 ³ Hz)				2.1	2.1	2.1	2.6	2.6	2.6	7.7
		(10 ⁶ Hz)				2.1	2.1	2.1	2.6	2.6	2.6	6.4
	Dissipation factor	(60Hz)	K6935	IEC60250	D150	0.0002	0.0002	0.0002	0.0012	0.0006	0.0005	0.049
		(10 ³ Hz)				0.0002	0.0002	0.0002	0.025	0.0008	0.0015	0.018
	(10 ⁶ Hz)				0.0002	0.0003	0.0005	0.020	0.005	0.015	0.017	
Arc resistivity	s			D495	>300	>300	>300	>300	75	18	60	
Chemical Resistance and other Properties	Water absorption rate	%(24h)	K7209	62	D570	0.01	0.01	0.01	0.01	0.03	0.01	0.03
	Flammability	(3.2mm thickness)	K7140	1210	UL-94	V-0	V-0	V-0	V-0	V-0	V-0	V-0
	Oxygen index		K6935	4589	D2863	>95	>95	>95	>95	32	60	43
	Influence of direct sunlight					none	none	none	none	none	none	none
	Chemical resistance				D543							
		Acid				outstanding	outstanding	outstanding	excellent	excellent	excellent	excellent
		Alkaline				outstanding	outstanding	outstanding	excellent	excellent	excellent	very good
Organic solvent					outstanding	outstanding	outstanding	very good	excellent	excellent	good	
Outstanding : Even under severe conditions remains unaffected by most chemicals and solvents. Excellent : Under certain conditions caution is necessary with some chemicals and solvents.						Very good : Caution and consideration of use conditions and used chemicals and solvents is necessary. Good : Melted by some solvents.						

※values in parenthesis are for test conditions ※The above information is taken from the Japan Fluoropolymer Industry Association's "Fluoropolymer handbook".



Creating a future
chukoh
CHUKOH CHEMICAL INDUSTRIES, LTD.

To Contact us:
International Trade Dept. ATT New Tower 10F, 2-11-7, Akasaka, Minato-ku, Tokyo
107-0052 JAPAN
TEL (03) 6230-4417 FAX (03) 6230-4446

Offices & Plants

Head Office	ATT New Tower 10F, 2-11-7, Akasaka, Minato-ku, Tokyo 107-0052 JAPAN TEL (03) 6230-4411 FAX (03) 6230-4412
Fukuoka Head Office	Otemon Pine Building, 5F, 1-1-12, Otemon, Chuo-ku, Fukuoka 810-0074 JAPAN TEL (092) 724-1411 FAX (092) 724-1412
Tokyo Branch	ATT New Tower 10F, 2-11-7, Akasaka, Minato-ku, Tokyo 107-0052 JAPAN TEL (03) 6230-4411 FAX (03) 6230-4412
Nagoya Branch	Nishiki Park Building, 10F, 2-4-3, Nishiki, Naka-ku, Nagoya 460-0003 JAPAN TEL (052) 229-1511 FAX (052) 229-1512
Osaka Branch	Shinosaka Kimura Daiichi Building, 2F, 5-11-8, Nishinakajima, Yodogawa-ku, Osaka 532-0011 JAPAN TEL (06) 6307-2411 FAX (06) 6307-2412
Fukuoka Branch	Otemon Pine Building, 5F, 1-1-12, Otemon, Chuo-ku, Fukuoka 810-0074 JAPAN TEL (092) 724-1411 FAX (092) 724-1412
Membrane Sales Dept.	ATT New Tower 10F, 2-11-7, Akasaka, Minato-ku, Tokyo 107-0052 JAPAN TEL (03) 6230-4424 FAX (03) 6230-4446
Market Development Dept.	ATT New Tower 10F, 2-11-7, Akasaka, Minato-ku, Tokyo 107-0052 JAPAN TEL (03) 6230-4415 FAX (03) 6230-4446
International Trade Dept.	ATT New Tower 10F, 2-11-7, Akasaka, Minato-ku, Tokyo 107-0052 JAPAN TEL (03) 6230-4417 FAX (03) 6230-4446
Shanghai Office	Room 2014, Far East International Plaza, No.317, Xianxia Road, Changning District, Shanghai, People's Republic of China TEL +86-21-6235-1160 FAX +86-21-6235-1140

ISO 9001 and 14001 certification

We have been registered / certified to ISO 9001 and ISO 14001 with respect to the following the scope of registration.



The Scope of the Registration

Design & Development, Production for all products, such as, the Products contained fluorocarbon plastics, the Fabrics coated with fluorocarbon resin, the Products coated with Silicone and the Products contained Biodegradable resin.

Warnings

- Do not use in applications in contact with the human body such as medical care, etc.
- Dispose products in compliance with the related laws and regulations and absolutely do not incinerate them.
- Do not use the product where maximum temperature.
- Carefully read the catalog, product safety data sheet (MSDS), and fluoroplastic instruction manual in order to maintain functions essential to products and use products safely.